



# Wise and Match software

Operating manual • English	<b>EN</b>
Käyttöohje • Suomi	<b>FI</b>
Bruksanvisning • Svenska	<b>SV</b>
Bruksanvisning • Norsk	<b>NO</b>
Brugsanvisning • Dansk	<b>DA</b>
Gebrauchsanweisung • Deutsch	<b>DE</b>
Gebruiksaanwijzing • Nederlands	<b>NL</b>
Manuel d'utilisation • Français	<b>FR</b>
Manual de instrucciones • Español	<b>ES</b>
Instrukcja obsługi • Polski	<b>PL</b>
Инструкции по эксплуатации • По-русски	<b>RU</b>
操作手册 • 中文	<b>ZH</b>



# **OPERATING MANUAL**

**English**

## CONTENTS

<b>1.</b>	<b>WISE PRODUCTS AND THEIR ORDERING CODES</b> .....	3
<b>2.</b>	<b>USING KEMPPI DATAGUN PROGRAMMING DEVICE</b> .....	3
<b>3.</b>	<b>INSTALLING AND USING WISEROOT AND WISETHIN</b> .....	3
3.1	Controlling WiseRoot and WiseThin in FastMig Synergic .....	4
3.2	Controlling WiseRoot and WiseThin in FastMig Pulse .....	4
3.3	WiseRoot™ welding process.....	6
3.4	WiseThin™ welding process.....	6
3.5	WiseRoot/WiseThin process parameter regulation.....	7
3.6	Examples of joint preparation for WiseRoot.....	9
3.7	Welding techniques for WiseThin.....	10
3.8	Welding techniques for WiseRoot.....	10
3.8.1	WiseRoot basic technique.....	10
3.8.2	Pipe welding technique.....	11
<b>4.</b>	<b>INSTALLING AND USING WISEFUSION</b> .....	12
4.1	Controlling WiseFusion in FastMig Pulse and KempArc Pulse .....	12
4.2	WiseFusion – principle of operation.....	13
4.3	WiseFusion applications.....	14
4.3.1	Synergic MIG/MAG.....	14
4.3.2	Pulsed MIG/MAG.....	14
<b>5.</b>	<b>INSTALLING AND USING WISEPENETRATION</b> .....	15
5.1	WisePenetration in synergic FastMig and KempArc models.....	15
5.2	WisePenetration in FastMig Pulse and KempArc Pulse .....	16
5.3	WisePenetration – principle of operation .....	18
<b>6.</b>	<b>MATCH PRODUCTS AND THEIR ORDERING CODES</b> .....	19
<b>7.</b>	<b>USING MATCHLOG</b> .....	19
7.1	MatchLog in FastMig Synergic.....	19
7.2	MatchLog in FastMig Pulse .....	20
7.3	MatchLog operating in FastMig Synergic and FastMig Pulse.....	21
<b>8.</b>	<b>USING MATCHPIN</b> .....	21
8.1	MatchPin in FastMig Synergic.....	21
<b>9.</b>	<b>USING MATCHARCVOLTAGE</b> .....	22
9.1	MatchArcVoltage in FastMig Synergic.....	22
<b>10.</b>	<b>USING MATCHREPORT</b> .....	22
10.1	Example of a MatchReport certificate.....	23
<b>11.</b>	<b>USING MATCHCURVE</b> .....	23
<b>12.</b>	<b>USING MATCHCUSTOM</b> .....	23

## 1. WISE PRODUCTS AND THEIR ORDERING CODES

Ordering Information					
	Ordering code	KempArc Synergic	KempArc Pulse	FastMig Synergic	FastMig Pulse
WiseRoot	6265011			x	x
WiseRoot-A	9991011	x	x		
WiseThin	6265013			x	x
WiseThin-A	9991013	x	x		
WisePenetration	9991000			x	x
WisePenetration-A	9991010	x	x		
WiseFusion	9991014				x
WiseFusion-A	9991015		x		

## 2. USING KEMPPI DATAGUN PROGRAMMING DEVICE

**Kemppi DataGun** is a small handheld device that you can use to buy and install welding software to your Kemppi welding machines. You can use it also for updating, as well as for backing up and restoring the software content of your welding machine.

For using the Kemppi DataGun you need to have an account in Kemppi Channel, which is an online extranet service for Kemppi's dealers and key account customers.

First you connect the DataGun to your PC for buying and loading Wise and Match welding software products. Then you just connect the DataGun to a Kemppi welding machine, and it will automatically install the software.

## 3. INSTALLING AND USING WISEROOT AND WISETHIN

You can order WiseRoot and WiseThin processes as software licences from Kemppi DataStore, which is Kemppi's Web store offering software products. After downloading licences, you install them to your welding machine using the DataGun.

These processes can be installed to FastMig Synergic, KempArc SYN, FastMIG Pulse, and KempArc Pulse machines. After installation, the WiseRoot and WiseThin processes are available for use.

With FastMig Synergic and KempArc models there is no need to make a separate purchase of basic welding programs (welding curves). With FastMig Pulse and KempArc Pulse models you can choose the welding programs you need.

### 3.1 CONTROLLING WISEROOT AND WISETHIN IN FASTMIG SYNERGIC

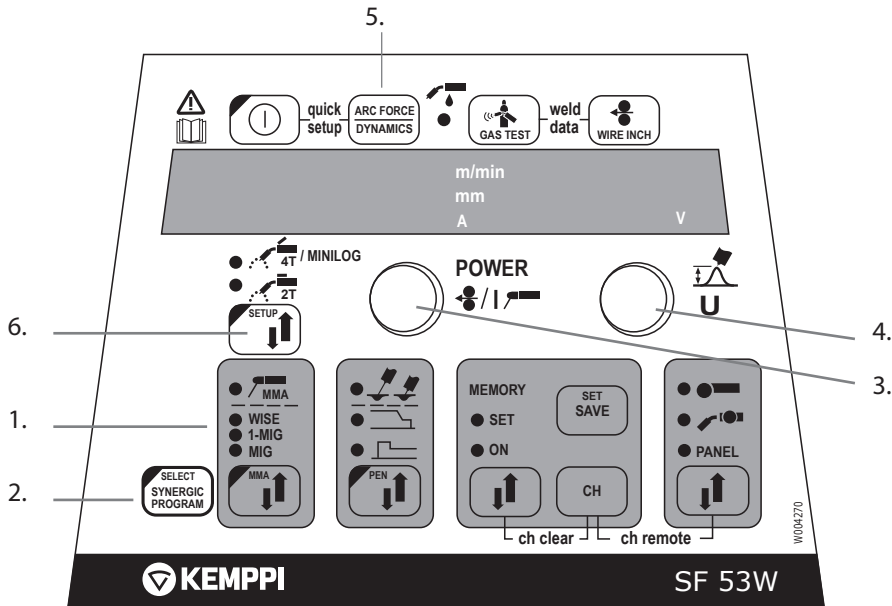

Controls used for adjusting WiseRoot and WiseThin features on a wire feeder control panel.

#### The basic control functions of WiseRoot and WiseThin:

1. The 'Wise' indicator light shows that a Wise process is in use.
2. The SYNERGIC PROGRAM button allows you to select which process and welding program to use:
  - Press the button for at least 5 seconds.
  - Select the desired welding program by turning the knob (3).
  - WiseRoot programs begin with 8 (8xx) and WiseThin programs with 7 (7xx).
3. Wire feed speed adjustment for WiseRoot and WiseThin.
4. Base current (BC) adjustment for WiseRoot and WiseThin.
5. Forming pulse (FPu) adjustment for WiseRoot and WiseThin.
6. With a long press of the SETUP button you can adjust the following:
  - Start time (Fst) of WiseRoot and WiseThin
  - Start voltage (Ful) of WiseRoot and WiseThin

EN

### 3.2 CONTROLLING WISEROOT AND WISETHIN IN FASTMIG PULSE

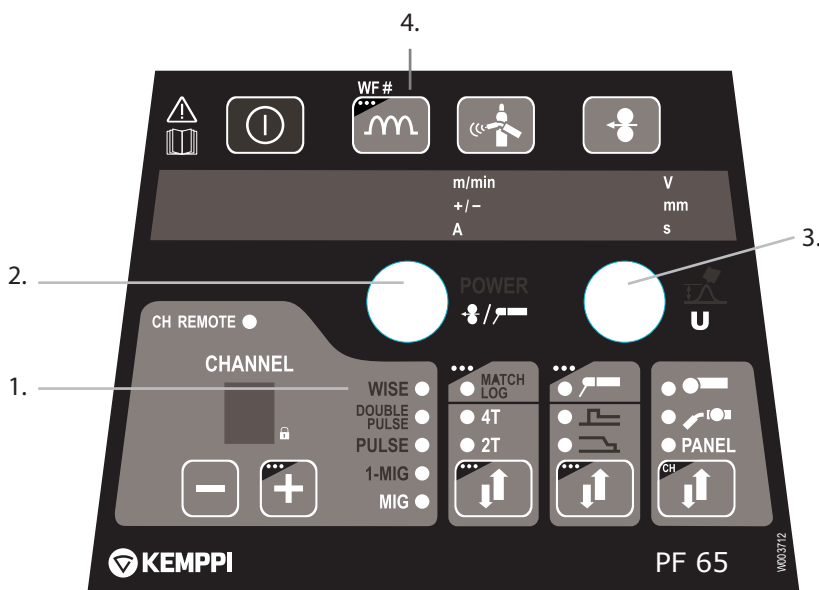

Controls used for adjusting WiseRoot and WiseThin features on a wire feeder control panel.

**The basic control functions of WiseRoot and WiseThin:**

1. The 'Wise' indicator light shows that a Wise process is in use.
2. Wire feed speed adjustment for WiseRoot and WiseThin.
3. Base current (BC) adjustment for WiseRoot and WiseThin.
4. Forming pulse (FPu) adjustment for WiseRoot and WiseThin.

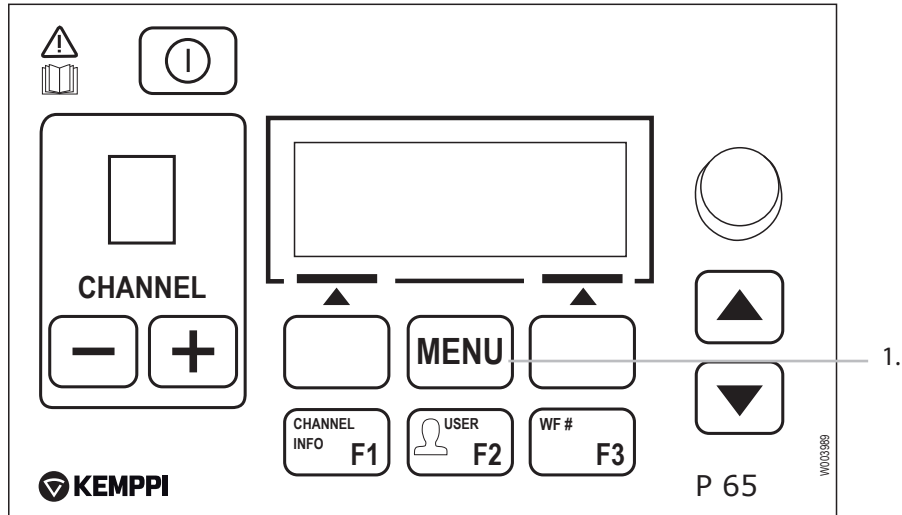

Controls used for adjusting WiseRoot and WiseThin features on a power source control panel.

**The basic control functions of WiseRoot and WiseThin:**

1. Press MENU button and follow these instructions to activate WiseRoot or WiseThin in the desired memory channel:
  - Select **Create new**.
  - In **CHOOSE PROCESS**, select either WiseRoot or WiseThin.
  - In **CHOOSE GROUP**, select the desired group.
  - In **CHOOSE MATERIAL**, select the desired material.
  - In **CHOOSE DIAMETER**, select the filler wire diameter
  - In **CHOOSE GAS**, select the desired shielding gas.
  - In **CHOOSE CURVE**, select the desired welding program.
  - In **SELECT MEMORY CH**, select the memory channel where you want to store the WiseRoot or WiseThin process.
2. Set the WiseRoot and WiseThin parameters in WELDING PARAMETERS menu:
  - **WFSpeed: x m/min**
  - **WFS-Max: x m/min** (You can replace the WFS max level)
  - **WFS-Min: x m/min** (You can replace the WFS min level)
  - **BaseCurrent: 0** (Same as BC)
  - **BaseCurrentMax: 50** (You can replace the BC max level)
  - **BaseCurrentMin: -50** (You can replace the BC min level)
  - **FormingPulse: 0** (Same as FPu)
  - **FormingPulseMax: 30** (You can replace the FPu max level)
  - **FormingPulseMin: -30** (You can replace the FPu min level)
  - **Starttime: 0** (Same as Fst)
  - **StartVoltage: 0** (Same as Ful)

### 3.3 WISEROOT™ WELDING PROCESS

In WiseRoot process, the welding current and voltage are controlled digitally. The correct and accurate adjustment of parameters makes the welding arc stable and virtually spatter free, which results in excellent weld quality. Heat input is also very low, which minimises distortion. Technically WiseRoot is a MIG/MAG welding process 131, 133, 135 or 138 according to standard EN ISO 4063. It is a tailored short arc process for root pass welding where the material transfer happens in two phases. The process differs a lot from traditional short arc processes.

WiseRoot™	Traditional short arc (dotted line)
<b>Short circuit period:</b>	
Filler wire contacts the work piece and shorts	Filler wire contacts the work piece and shorts
Welding current rises rapidly, which forces the tip of the wire in pinch mode	Welding current rises until pinch mode has happened
Droplet detaches and smoothly transfers into the weld pool	Droplet detaches and transfers into the weld pool
<b>Arc period:</b>	
Welding arc reignites in low current value	Welding arc reignites in high current value
Wire and the groove faces melt	Wire and the groove faces melt
Controlled arc force forms a molten weld pool	Molten weld pool is formed
Current quickly returns to base current level	Current slowly decreases to base current level

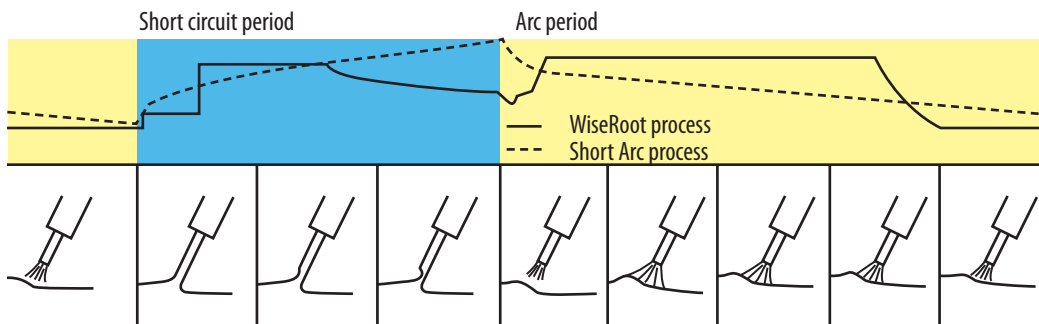

#### Welding programs for WiseRoot

There are various welding programs available for WiseRoot that can be used with the most common wire types, wire diameters and shielding gases for steels (Fe), stainless steels and MIG brazing. Their availability depends on the machine type (standard or MatchCurve).

Kemppi also offers customer-specific welding programs for WiseRoot. They are designed and created to order (MatchCustom).

### 3.4 WISETHIN™ WELDING PROCESS

WiseThin is a MIG/MAG welding process, where power source's welding current and voltage parameters are controlled digitally. It monitors the short circuit and controls the correct timing of the filler droplet's transmission from the filler wire into the weld pool. WiseThin is an optimized cold arc process for sheet metal welding, where heat input must be minimised.

Technically, WiseThin is a MIG/MAG welding process 131, 133, 135 or 138 according to standard EN ISO 4063.



Basic characteristics of WiseThin process are the same as those of WiseRoot. However, there are following differences between WiseThin and WiseRoot processes:

- WiseThin is optimized for sheet metal welding, whereas WiseRoot is optimized for root pass welding. With sheet metals we refer to plate thickness less than 2 mm.
- In WiseThin process, the frequency and arc behaviour allow higher welding speeds than in WiseRoot.

### Welding programs for WiseThin

There are various welding programs available for WiseThin that can be used with the most common wire types, wire diameters and shielding gases for steels (Fe), stainless steels and MIG brazing. Their availability depends on the machine type (standard or MatchCurve).

Kemppi also offers customer-specific welding programs for WiseThin. They are designed and created to order (MatchCustom).

## 3.5 WISEROOT/WISETHIN PROCESS PARAMETER REGULATION

Normally there's no need to change the default factory settings of WiseRoot and WiseThin processes, because they suit perfectly for most applications. However, if you want to further customise their behaviour, you can fine tune their characteristics in the following manner.

You can adjust the start time from the control panel menu. This might be useful if you are welding really thick materials and you want to put more power to the start to ensure the necessary root side penetration.

### WiseRoot "power start" with synergic MIG

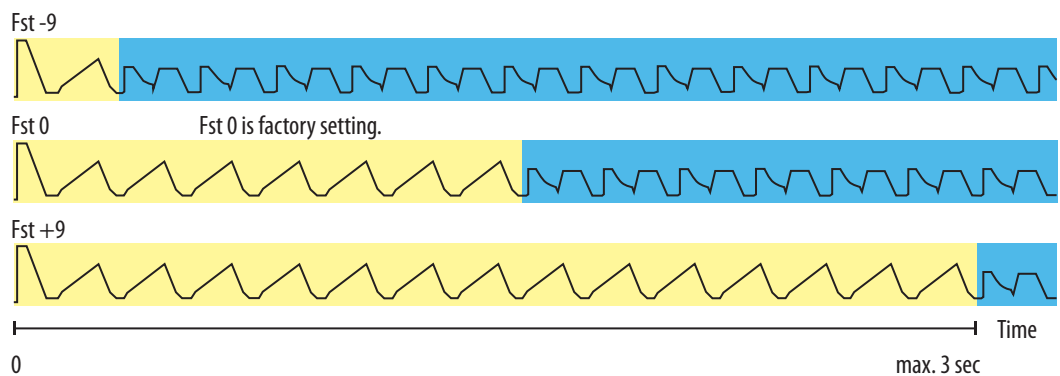

*In synergic MIG, WiseRoot starts with voltage regulation. After predetermined time, Fst process changes from synergic MIG to WiseRoot. The WiseRoot and synergic MIG time (Fst) as well as voltage level (Ful) can be adjusted from the control panel if needed.  
(Yellow = short-circuit period, blue = WiseRoot period)*

Welding power (wire feed speed) is the main parameter (arc energy and heat input).

Base current (BC) adjustment allows you to change the arc energy. The higher base current means more heat input in the welded material.

Forming pulse (FPu) adjustment allows you to change the forming pulse level. The higher adjustment means more force to the arc. The arc force must be great enough for the weld to penetrate through, but too much arc force makes the weld pool restless and difficult to control.

Stick out length adjustment allows you to change the frequency. Less stick out length means more frequency.

The process tolerates root gap variations in certain limits, but the wire feed speed value must be suitable for the used root gap.

**WiseThin**

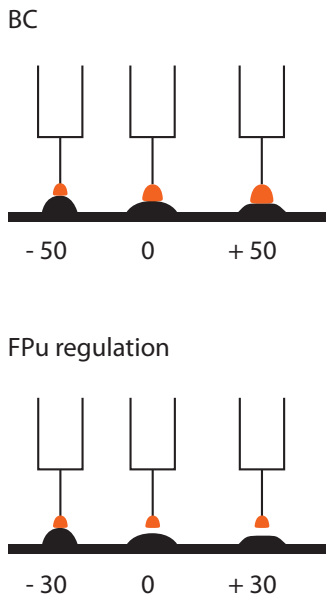

**WiseRoot**

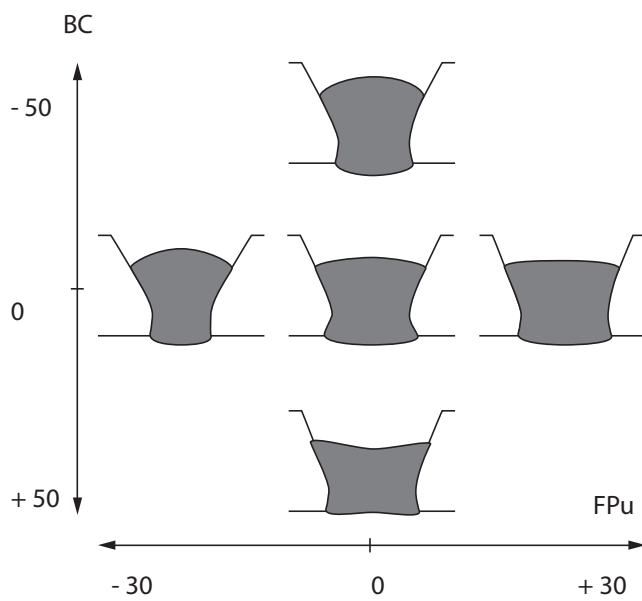

BC and FPU adjustment affects levels of forming pulse and base current.  
 In the end there is possibility to use more energy to melt grooves of the tack weld.

**FastMig crater fill function**

	CraterFill = OFF
	CraterFill = ON StepLevel (CrS) = 30%, EndLevel (CrL) = 30%, Time (CrT) = 2.0 s
	CraterFill = ON StepLevel (CrS) = 80%, EndLevel (CrL) = 30%, Time (CrT) = 2.0 s
	CraterFill = ON StepLevel (CrS) = 150%, EndLevel (CrL) = 50%, Time (CrT) = 2.0 s
	CraterFill = ON StepLevel (CrS) = 150%, EndLevel (CrL) = 150%, Time (CrT) = 2.0 s

Maximum value for CrS and CrL is 250%, maximum value for CrT is 9.9 s in 2T mode, and in 4T mode the crater fill function is on until stopped.

### 3.6 EXAMPLES OF JOINT PREPARATION FOR WISEROOT

WiseRoot requires the use of root gap of about 1 – 10 mm wide, depending on plate thickness and application.

#### Possible groove types for WiseRoot welding

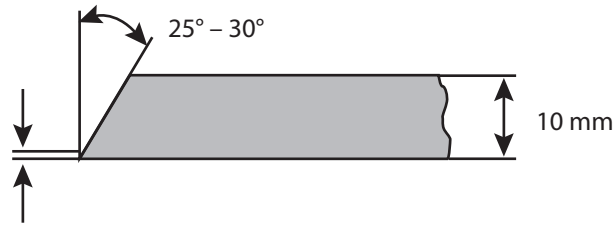

0 – 1.0 mm

Groove angle depends on the material thickness, pipe diameter etc.  
Root face should be in the range of 0 – 1.0 mm.

#### Possible groove types for WiseRoot welding (thick)

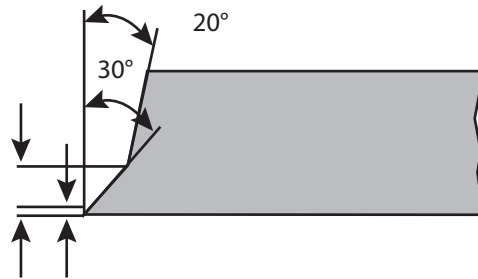

5.0 mm    0 – 1.0 mm

Root face should be in the range of 0 – 1.0 mm.

### 3.7 WELDING TECHNIQUES FOR WISETHIN

WiseThin is a welding process for sheet metals less than 2 mm in thickness. To find the correct parameters in lap joint welding, use the welding technique shown in the following pictures.

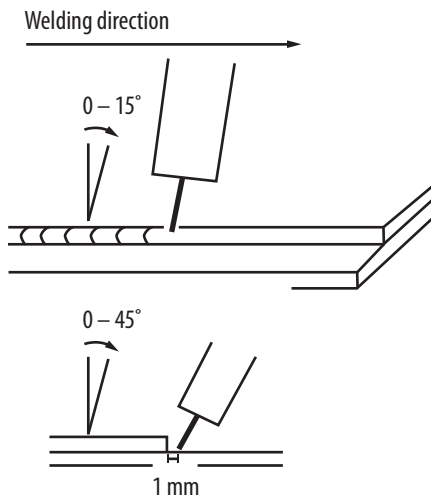

### 3.8 WELDING TECHNIQUES FOR WISEROOT

#### 3.8.1 WiseRoot basic technique

- Continuous oscillation without delays on groove edges
- Oscillation frequency is faster than in vertical up welding
- Welding power regulation according to groove opening and the root face.
- Travel speed and oscillation width
- Penetration increases with steepness of the pulling gun angle

*NOTE! Avoid too great oscillation – try to use maximum travel speed.*

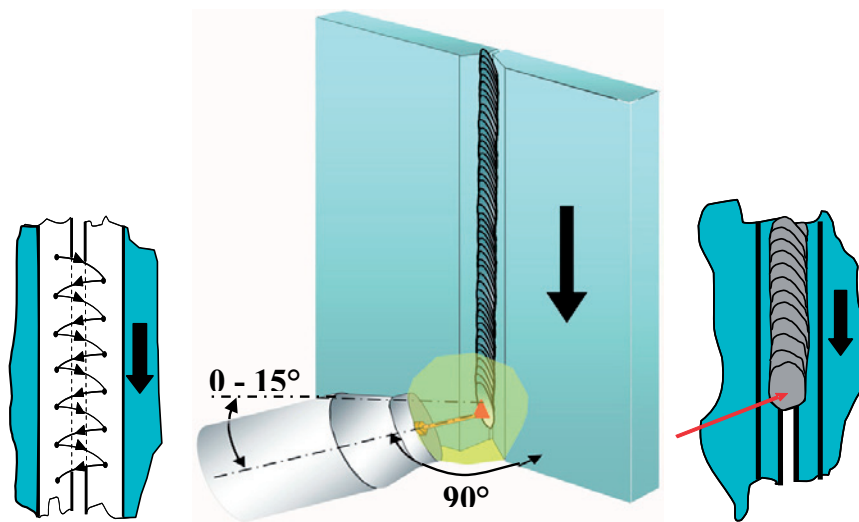

Focus the welding arc to this point.

### 3.8.2 Pipe welding technique

#### WiseRoot

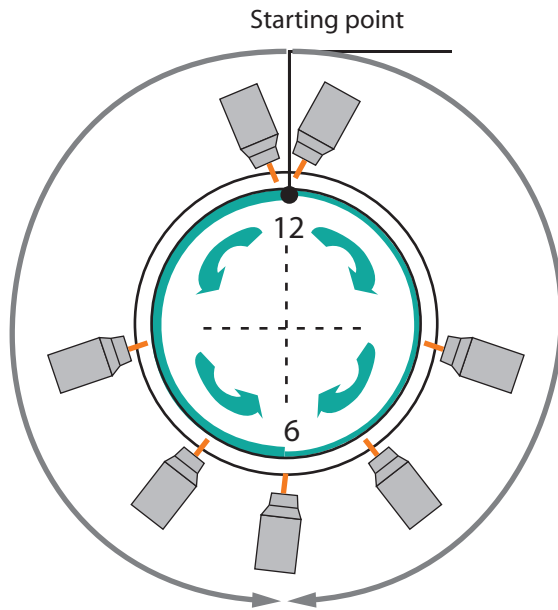

- Pulling gun angle  $10^{\circ} - 15^{\circ}$
- Overhead  $5^{\circ}$  to  $6^{\circ}$  angle
- Arc carries the weld pool
- Vertical down welding
- Oscillation:
- Flat / 12 Yes
- Vertical / 3 / 9 Yes
- Overhead / 6 Yes
- Continuous oscillation without delays on groove edges

**For filling passes use synergic MAG with solid or flux-cored wire**

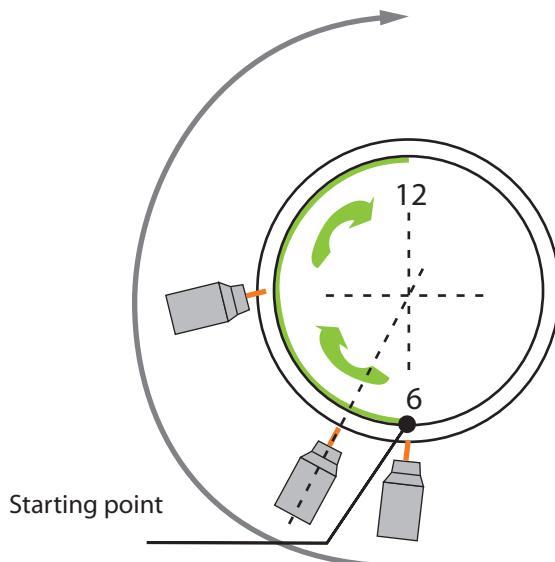

- Straight  $90^{\circ}$  gun angle
- Vertical up welding technique
- Gun points to the centre of the pipe
- Oscillation: Yes
- Oscillation with delays on groove edges

## 4. INSTALLING AND USING WISEFUSION

You can order WiseFusion function as a software licence from Kemppe DataStore, which is Kemppe's Web store offering software products. After downloading the licence, you install it to your welding machine using the DataGun. WiseFusion can be installed to FastMIG Pulse and KempArc Pulse machines.

*NOTE! In KempArc Pulse TCS equipment for robotic tandem MIG/MAG welding, the WiseFusion is included in standard delivery package.*

WiseFusion works with all synergic and pulsed MIG welding programs and with double pulsed welding programs. WiseFusion license does not include any welding programs, but you can order them separately as MatchCurve software products.

After installation, the WiseFusion is available for use.

### 4.1 CONTROLLING WISEFUSION IN FASTMIG PULSE AND KEMPARC PULSE

When you have installed the WiseFusion on your welding machine, you can take it into use by using the power source's control panel. Remember that first you have to set welding process to the memory channel:

1. Press **MENU** button on the control panel.
2. Select **Edit channel**.
3. Select **Advanced functions**.
4. Select **WiseFusion ON**.
5. In **WiseFusion % CURVE**, adjust in the range 10 – 60 %.

Curve is the default value, and the percentage value can be adjusted in the range 10 – 60 %. Default Curve value for aluminium is 50 %, for steels 35 %, and for other materials 40 %.

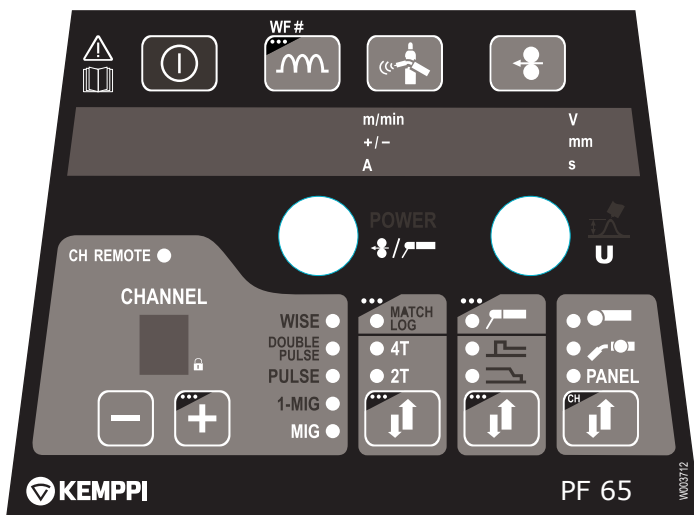
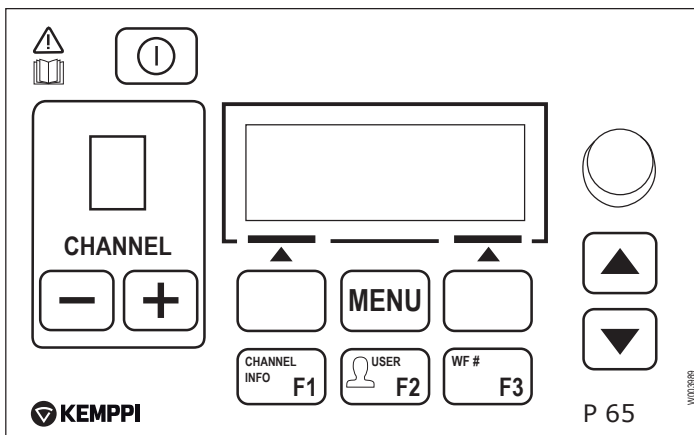

When WiseFusion is in use, the 'Wise' indicator and the chosen welding process indicator are lit on control panel PF65 or the remote control panel KF62. On power source control panel P65, the display also reads 'WiseFusion'.

When WiseFusion is selected, the welding arc stays automatically in the short circuit limit, and the arc remains short. With the WiseFusion %-value you can set the amount of short circuiting: lower value means less and higher value more short circuiting. The %-value affects also the length of welding arc. The lower %-values give longer welding arc.

#### 4.2 WISEFUSION – PRINCIPLE OF OPERATION

WiseFusion is a function that allows adaptive regulation of welding arc length in MIG/MAG welding. The adaptive arc length regulation keeps the synergic spray arc and pulsed arc optimally short. The following set of pictures shows how WiseFusion affects pulsed MIG welding: in the third picture you can see how welding arc short-circuits without creating any spatter. The adaptive regulation makes the welding arc shorter and more concentrated.

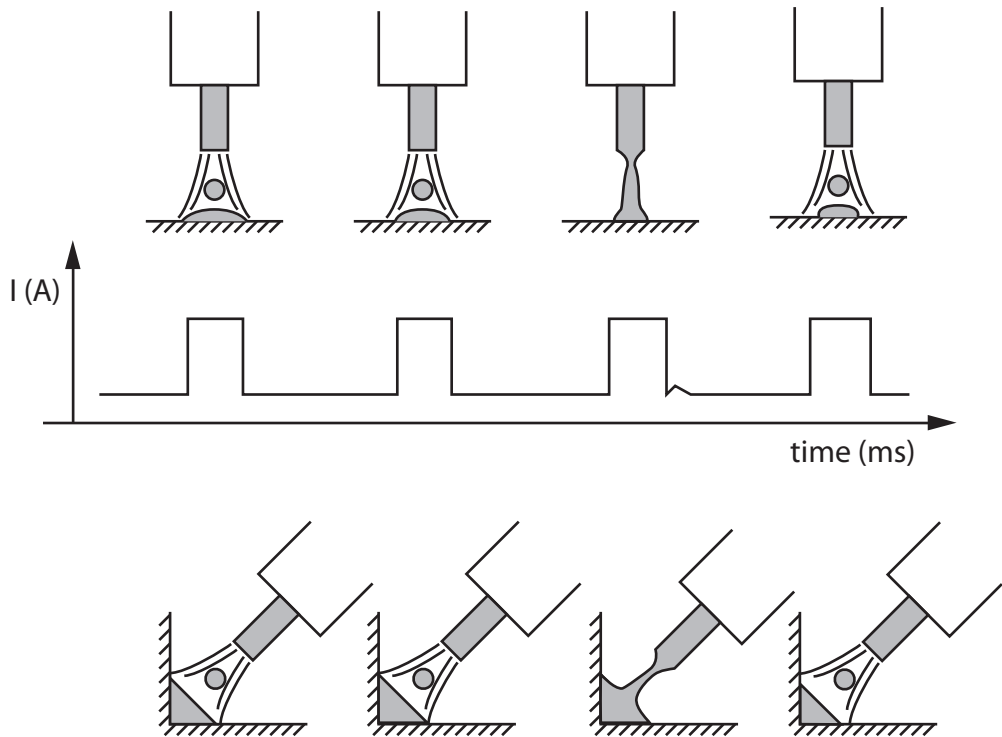

Figure. Pulse sequence, where the filler droplet short-circuits before detaching.

In pulsed arc WiseFusion welding, the %-value indicates the number of short circuits in a pulse sequence. For example, if %-value is 50, half of the droplets detach in open arc and half of them in short circuit.

In synergic spray arc, the power source keeps track of the number of short circuits so that it remains on the level defined by the WiseFusion %-value.

WiseFusion operates with all synergic and pulsed MIG/MAG welding programs.

## 4.3 WISEFUSION APPLICATIONS

### 4.3.1 Synergic MIG/MAG

WiseFusion makes it possible to achieve better quality welds and higher welding speeds. Because of the short and concentrated welding arc, it also helps you to weld narrow and deep grooves, which makes it possible to decrease the groove volume.

### 4.3.2 Pulsed MIG/MAG

#### Position welding, especially in aluminium

WiseFusion allows better pulse welding characteristics in position welding. Metal transfer happens in pulses, which are very close to the short circuit limit. This makes the arc optimally short and decreases the size of molten weld pool. The small weld pool facilitates position welding, especially with aluminium. Better weld pool control can be seen in the final weld, which will have standard quality both outside and inside.

Example: In fillet weld, position welding in vertical up position (PF) is easy to control even in straight welding gun movement.



Figure. Aluminium position welding.

#### Challenges with nickel based alloys

High-alloyed nickel based filler wires are used for welding heat and corrosion resistant steels. One of the challenging wires is 'Inconel 617'. A typical problem with it is that wire sticks to contact tip during welding, which causes unstable arc. The weld pool gets out of control and the risk for welding defects increases.

WiseFusion keeps the welding arc length optimally short and makes it more easy to manage the arc. Even in the case where the wire keeps sticking to the contact tip, you can control the arc and continue welding.

#### Ultra high strength steels

With high-strength steels the key issue is heat input. High heat input results in a wide soft area in the heat affected zone of the weld. Because the soft area is softer than base material, the impact toughness and yield strength are decreased. The table below shows that the heat input with WiseFusion is 15 % smaller than in a normal pulsed welding process and more than 25 % smaller than in normal MAG welding.

Process	wsf (m/min)	v (mm/min)	I (A)	U (V)	P (W)	Q (kJ/mm)	$\Delta Q$
MAG	12	450	235	32	7500	0.80	+ 26.83 %
Pulsed MAG	12	450	197	30	6409	0.68	+ 14.37 %
WiseFusion	12	450	182	27	5488	0.59	+ 0.00 %

Table: Heat input comparison between different welding processes  
(Q = heat input,  $\Delta Q$  = heat input difference)



## 5. INSTALLING AND USING WISEPENETRATION

You can order WisePenetration function as a software licence from Kemppi DataStore, which is Kemppi's Web store offering software products. After downloading the licence, you install it to your welding machine using the DataGun. WisePenetration can be installed to synergic and pulsed FastMig and KempArc models.

WisePenetration works with all synergic MIG welding programs. WisePenetration license does not include any welding programs, but you can order them separately as MatchCurve software products.

After installation, the WisePenetration is available for use.

### 5.1 WISEPENETRATION IN SYNERGIC FASTMIG AND KEMPARC MODELS

WisePenetration needs a synergic wire feeder control panel. Wire feeders MSF 53 and MXF 63 are equipped with control panel SF 52W. Wire feeders MSF 55, MSF 57, MXF 65 and MXF 67 are equipped with control panel SF 53W.

To activate WisePenetration you need to first select synergic 1-MIG welding process with the control panel button 11 (see following picture). To take the function into use, press button 13 for 5 seconds, so that the WisePenetration indicator goes on. Welding power and welding arc length can be adjusted normally with the knobs 14 and 16.

WisePenetration keeps the weld penetration in good level by actively adjusting the wire feed speed when stick-out length increases higher than the set level.

#### Adjusting the process

1. Choose the welding program according to the material, wire diameter and shielding gas you are using. Remember that WisePenetration works only in 1-MIG process.
2. Set welding power to suit the work piece and the groove. Make a test weld without WisePenetration. Use correct stick-out length and adjust the welding parameters. If you use wrong stick-out length, the setup won't be correct for WisePenetration. Write down the welding current value used in the test weld (you can find it in the wire feeder's or power source's control panel).
3. Activate the WisePenetration function. Set 'PEN' parameter so that the current value in the left display is close to the value used in test welding. When adjusting the 'PEN' parameter, the minimum welding current level is shown on the power source control panel display.
4. Make a new test weld using WisePenetration. Now you can see that the wire feed speed increases when using longer stick-out length (2).

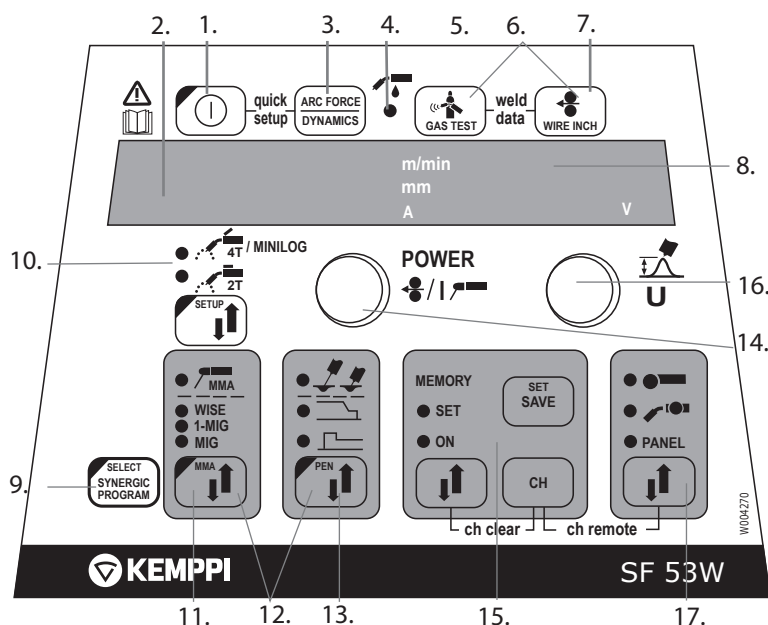

FastMig Synergic wire feeder panel SF 52W / SF 53W.

WisePenetration function can be activated in the control panel (PEN ON/OFF). The WISE indicator light shows that WisePenetration is in use.

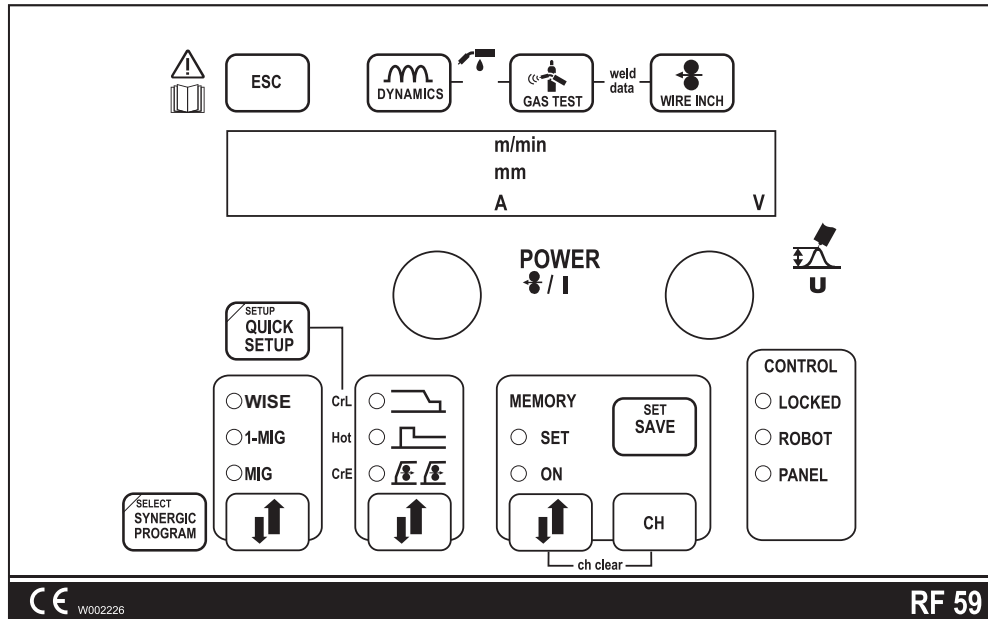

KempArc SYN control panel RF 59.

## 5.2 WISEPENETRATION IN FASTMIG PULSE AND KEMPARC PULSE

WisePenetration can be activated only when synergic 1-MIG process is in use. To activate WisePenetration with the power source control panel, do the following:

1. Select the memory channel (11) where you want to use WisePenetration.
2. Press MENU button. (3)
3. Use the arrow buttons (5) to browse to **Edit channel** and select it with button (8).
4. Use the arrow buttons to browse to **Advanced functions** and select it with button (8).
5. In menu item **WisePenetration On/Off** you can switch the function on or off with the adjustment knob (4).
6. In menu item **Penet%** you can set the threshold value of stick-out length and the minimum welding current level with the adjustment knob (4).

When WisePenetration function is in use, the welding power and welding arc length can be adjusted normally with the adjustment knobs 10 and 12.

### Adjusting the process

1. Choose the welding program according to the material, wire diameter and shielding gas you are using. Remember that WisePenetration works only in 1-MIG process.
2. Set welding power to suit the work piece and the groove. Make a test weld without WisePenetration. Use correct stick-out length and adjust the welding parameters. If you use wrong stick-out length, the setup won't be correct for WisePenetration. Write down the welding current value used in the test weld (you can find it in the wire feeder's or power source's control panel).
3. Activate the WisePenetration function. Set 'Penet%' parameter so that the current value in the left display is close to the value used in test welding. When adjusting the 'Penet%' parameter, the minimum welding current level is shown on the power source control panel display, for example Penet% (123A).
4. Make a new test weld using WisePenetration. Now you can see that the wire feed speed increases when using longer stick-out length (2).

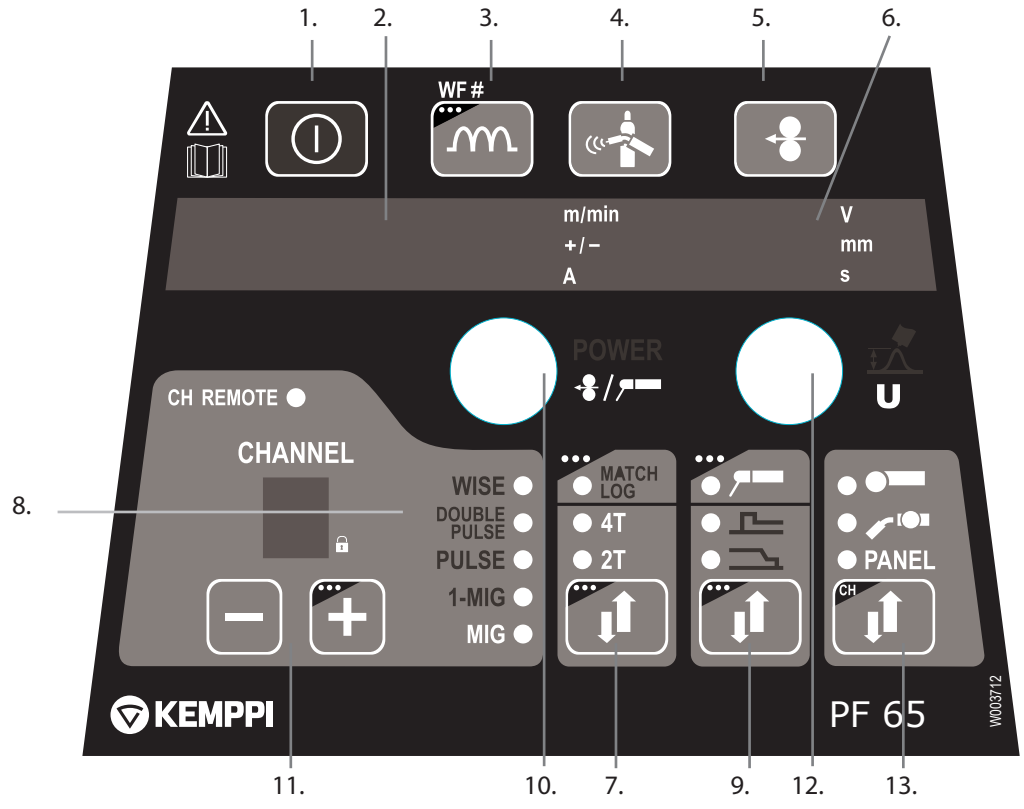

FastMig Pulse wire feeder panel PF65.

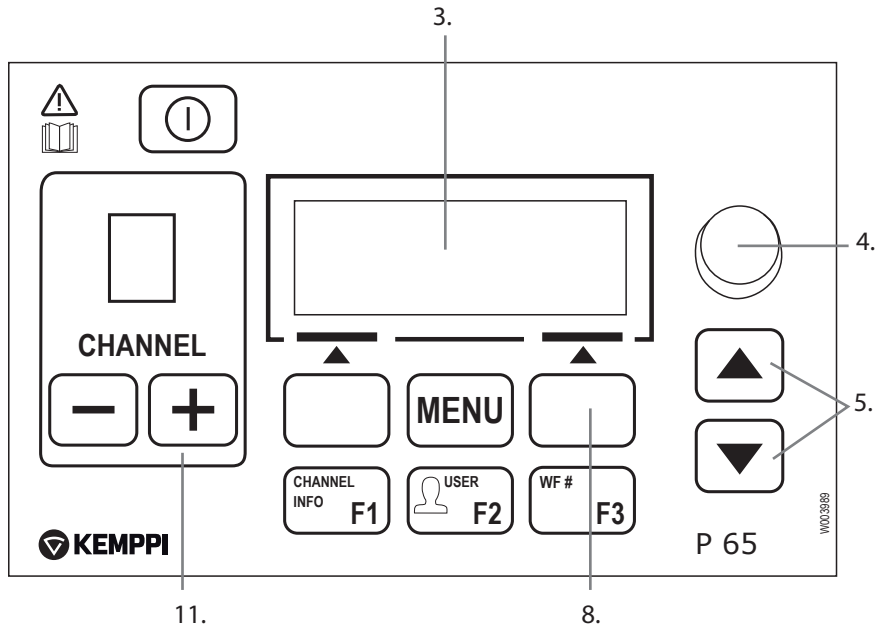

FastMig Pulse / KempArc Pulse power source panel P65 / KF62.

### 5.3 WISEPENETRATION – PRINCIPLE OF OPERATION

In MIG/MAG welding, constant voltage (CV) characteristics are most commonly used. The self-adjusting welding arc is the most important argument for the use of constant voltage characteristics. An increase in stick-out length will cause welding power to drop, because welding current decreases ( $P = U \times I$ ).

Changes in stick-out length have no effect on wire feed speed or arc voltage. Instead, welding current fluctuates according to the changes in stick-out length.

#### Example:

The following picture shows how welding current changes with stick-out length when welding S235 steel with 1.2 mm wire and using Ar + 18% CO<sub>2</sub> shielding gas and the following welding parameters: wire feed speed 8.8 m/min, voltage 29.0 V, travel speed 58.0 cm/min.

Welding current depends on the stick-out length because of using constant voltage characteristics. The greater the stick-out length, the lower welding current. This can cause serious welding defects, such as lack of fusion, incomplete penetration, unstable weld quality and spatter.

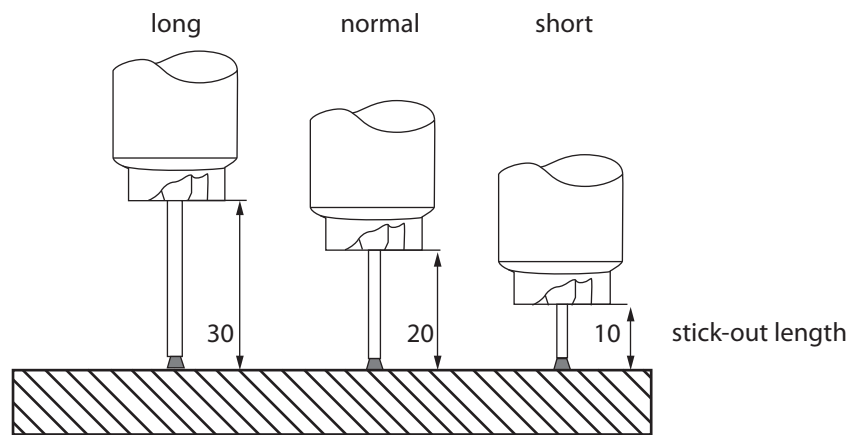

No WisePenetration	240 A	280 A	330 A
With WisePenetration	280 A	280 A	330 A

(Setup value for WisePenetration is 280 A)

WisePenetration prevents welding current from dropping down by actively adjusting the wire feeding. This helps to keep the mechanical properties of the weld on desired level and prevents welding defects.

WisePenetration offers constant welding current with stick-out length within the limits defined in welding procedure specification (WPS). When welding with stick-out lengths within the permitted limits, WisePenetration operates like conventional MIG/MAG process and lets welding current fluctuate with the stick-out length. However, if stick-out length increases above the permitted level, WisePenetration takes the control and ensures that the current remains constant.

## 6. MATCH PRODUCTS AND THEIR ORDERING CODES

<b>MatcArcVoltage</b>	FastMig Synergic	9991018
<b>MatchLog</b>	FastMig Pulse, Fastmig Synergic	9991017
<b>MatchCurve</b>	FastMig Synergic, FastMig Pulse	9990401
<b>MatchPIN</b>	FastMig Synergic	6265026
<b>MatchReport</b>		9991019
<b>MatchCustom</b>	FastMig Pulse, FastMig Synergic	9990402

## 7. USING MATCHLOG

*NOTE: MatchLog function may also be referred with the name Minilog.*

With the MatchLog function you can quickly and easily change welding power momentarily during welding pressing down the welding gun trigger. For example, if there are tack welds in the groove, you can increase welding power momentarily when running over the tack welds, and then return to normal power level without having to stop welding.

You can order MatchLog function as a software licence from Kemppi DataStore. After downloading the licence, you install it to your welding machine using the DataGun. MatchLog can be installed to FastMig Synergic and FastMig Pulse machines.

### 7.1 MATCHLOG IN FASTMIG SYNERGIC

(In FastMig Synergic, Matchlog function is called 'Minilog')

#### Minilog function in wire feeder control panel

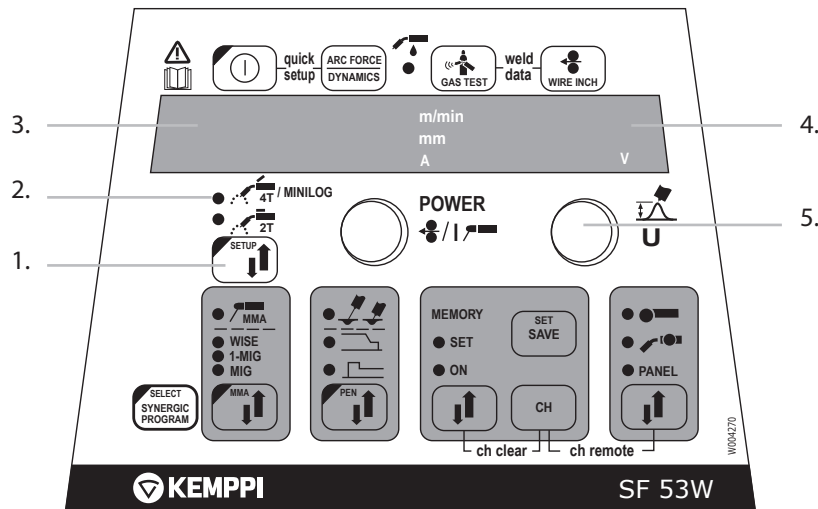

#### Basic features of Minilog function:

In the control panel Setup menu, there are two Minilog parameters: ML is used for turning Minilog function on and off, and MLo MLo is used for setting the power level for Minilog function. To take the Minilog function into use, do the following:

1. Activate the Minilog function by pressing SETUP button (1) until the 4T/Minilog indicator starts blinking.
2. Adjust the Minilog power level (MLo parameter) with the adjustment knob (4). When adjusting the parameter, you can see the Minilog level wire feed speed on the display (3).
3. MLo adjustment range is -99 ... 200, where 0 represents the normal welding power level.

## 7.2 MATCHLOG IN FASTMIG PULSE

### MatchLog in wire feeder panel.

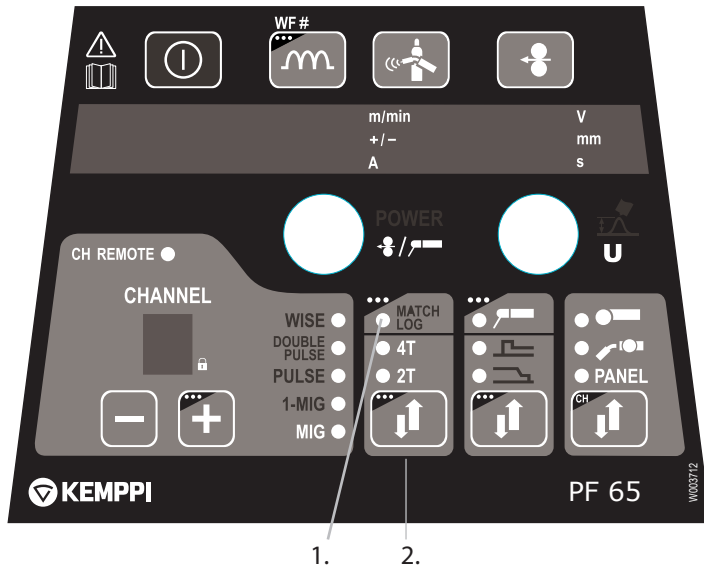

### Basic features of MatchLog function:

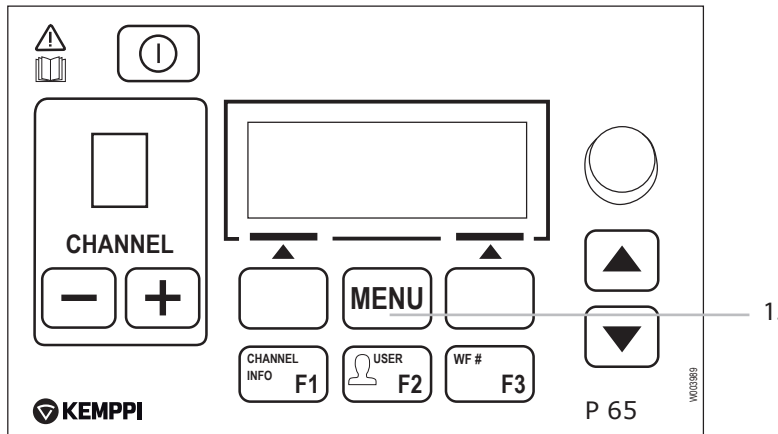

MatchLog function is in use, when the indicator light is on (1). To activate the MatchLog function, to the following:

1. Press the MENU button (1) for at least 5 seconds
2. Take MatchLog function into use:
  - Browse to **Edit channel** or **Create channel** and press Select.
  - In WELDING FUNCTIONS point to **2T/4T** and select **MatchLog**.
3. Adjust the MatchLog settings:
  - Browse to **Edit channel** or **Create channel** and press Select.
  - Browse to **Advance functions** and press Select.
  - Browse to **MatchLog Menu** and press Select.
  - Adjust the MatchLogLevel parameter value in the range -99 ... 125 %, where value 0 represents the normal welding power setting.
  - Press **Save**.

## 7.3 MATCHLOG OPERATING IN FASTMIG SYNERGIC AND FASTMIG PULSE

### MatchLog trigger technique

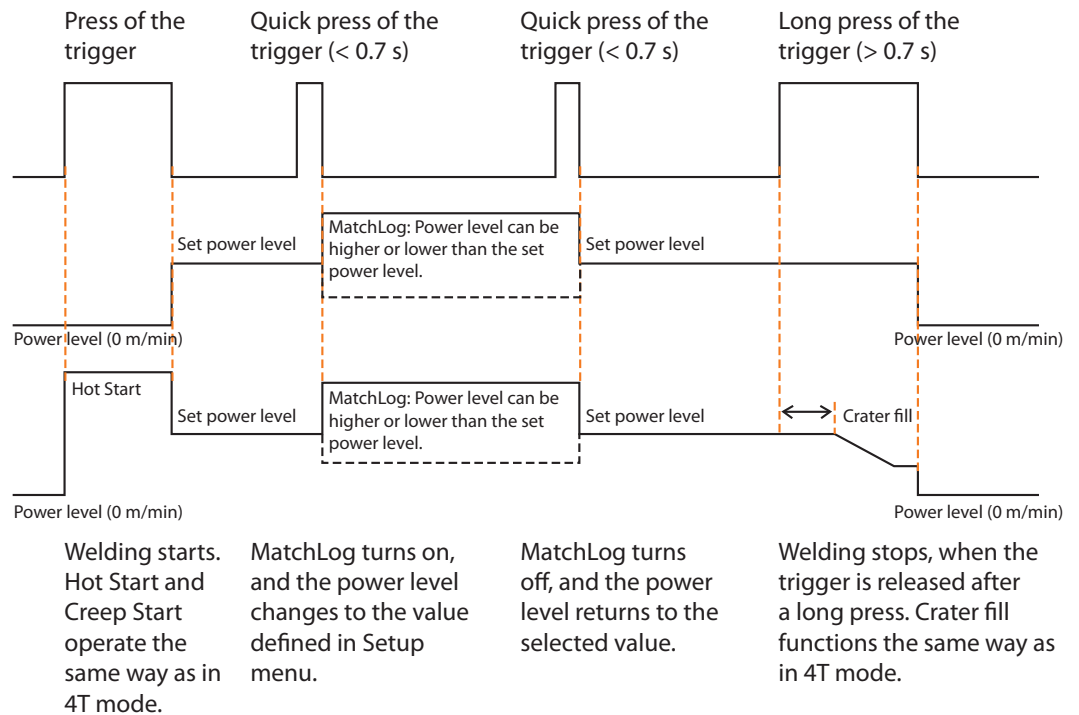

## 8. USING MATCHPIN

With the MatchPin function you can lock the welding machine's control panel to prevent unauthorised use and unwanted modification of your welding parameters. To use the control panel, you need to first enter the PIN code.

You can order MatchPin function as a software licence from Kemppi DataStore. After downloading the licence, you install it to your welding machine using the DataGun.

### 8.1 MATCHPIN IN FASTMIG SYNERGIC

MatchPin is activated through the Setup menu of wire feeder's control panel. The 'Pin' parameter represents the 3 digit access code. You can enter it with the left control knob.

#### To lock your memory channels from unauthorised use, do the following:

1. Open the control panel's Setup menu and select LoC On mode
2. Exit the menu.
3. Lock the memory channels by selecting memory channels ON mode

When the control panel is locked, users can only select Panel OFF mode, Local/Remote (CH Remote), Memory Channel Number, Gas Test, Weld Data, Water/Gas and Wire Inch. All other options are not available.

#### To unlock panel, do the following:

To unlock panel, press simultaneously buttons MEMORY, SET/SAVE and ARC FORCE. The display shows "LoC OFF".

## 9. USING MATCHARCVOLTAGE

You can order MatchArcVoltage function as a software licence from Kemppi DataStore. After downloading the licence, you install it to your welding machine using the DataGun, Kemppi's field programming device.

If you need to track the arc voltage instead of pole voltage for a long time, you can use MatchArcVoltage function, which makes the control panel to show arc voltage value instead of pole voltage. This is useful for example when monitoring WPS welding parameters.

Normally, a welding machine measures the secondary voltage from the power source poles, and this value is shown in wire feeder's or power source's control panel.

The actual arc voltage value is smaller than the pole voltage, because some voltage loss always happens in the cables, depending on the welding cable size and length. Voltage loss happens in intermediate cable, earth return cable and in welding gun cable. The most significant losses happen usually in in intermediate cable.

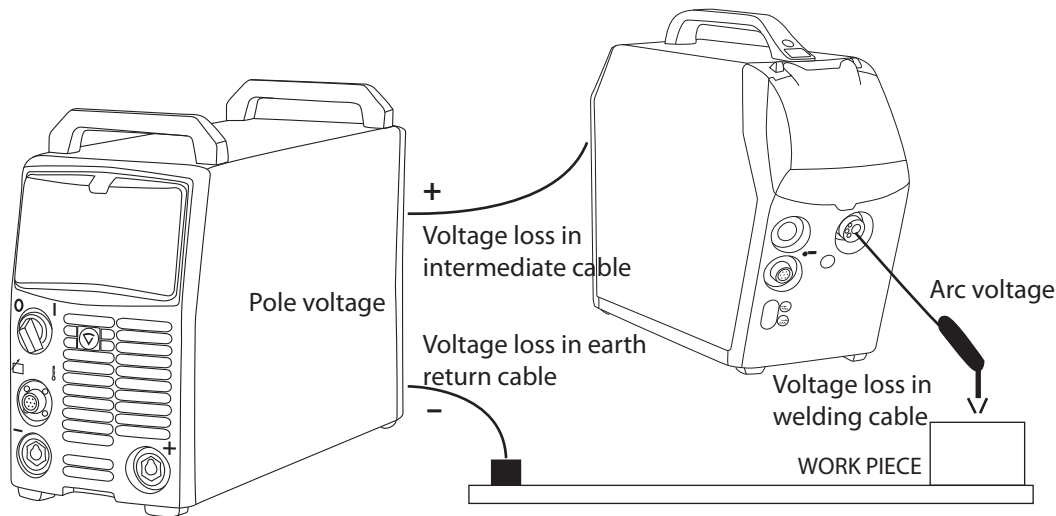

### 9.1 MATCHARCVOLTAGE IN FASTMIG SYNERGIC

To start using the MatchArcVoltage, open the Setup menu in the control panel and select the parameter 'cab' and enter the cable length in meters. If you have a long earth return cable, you must calculate the total length of the cable and enter the total value.

After setting the cable length, select the parameter 'Ard' and turn it on. Now the display shows arc voltage instead of pole voltage.

The control panel calculates the arc voltage value using the welding current value, the pole voltage value and the cable lengths that you specified.

## 10. USING MATCHREPORT

MatchReport (a validation certificate) is a machine-specific document of the manufacturing, testing and in-production calibration of the machine. You will need the MatchReport for example if a customer or project owner requires a validation certificate for a machine.

To buy a validation certificate, log on to Kemppi DataStore and enter the serial number of the device.

*NOTE! MatchReport does not substitute the declaration of conformity.*



## 10.1 EXAMPLE OF A MATCHREPORT CERTIFICATE



### Test and Validation Certificate

1 (1)

#### Product Information

Product name: MASTER MLS 2500  
 Product Number: 6104  
 Serial Number: 1786

#### Certificate Information

Date printed: 04.06.2010  
 Version: 280110A

Kemppi Oy certifies that at time of manufacture, the above product was tested/calibrated in accordance with applicable Kemppi Oy procedures. These procedures are in compliance with relevant clauses of ISO 9001 and are designed to assure that the product listed above meets specifications according to norms EN-60974-1 and IEC 60974-1 (Safety requirements for arc welding equipment Part 1:Welding power sources).

Kemppi Oy further certifies that the measurement standards and instruments used during the testing and calibration of this product are traceable to the national or international measurement standards or are derived from accepted values of natural physical constants.

#### General Test Information

Test Station (Safety):	671409	This product was assembled by:	1440
Test Station (Functional):	200054	This product was inspected by:	
Test Sequence:	MASTER XX00 MLS	Dielectric Strength:	5940
Test Sequence rev:	D6	Functional test/Calibration:	5940
Test/Cal Date:	01.12.2009	Test/Cal Status:	PASS

#### Test Results

Test ID	Number	Measured value	Low limit	High limit	Status	Test notes
Supply voltage (L2-L3)	5	401,025 V	395,000	405,000	PASS	
No-load supply current (L1)	13	0,172 A	0,000	0,400	PASS	
No-load supply current (L2)	13	0,163 A	0,000	0,400	PASS	
No-load supply current (L3)	13	0,153 A	0,000	0,400	PASS	
No-load voltage (PEAK)	73	82,248 V	40,000	95,000	PASS	MMA
No-load voltage (MEAN)	74	80,009 V	79,500	80,500	PASS	MMA
Welding current (MAX)	108	254,312 A	250,000	255,000	PASS	MMA
Load voltage (MAX)	109	30,201 V	29,800	30,400	PASS	MMA
Max. Supply current (L1)	110	12,776 A	11,500	13,500	PASS	MMA
Max. Supply current (L2)	110	12,889 A	11,500	13,500	PASS	MMA
Max. Supply current (L3)	110	13,012 A	11,500	13,500	PASS	MMA
Welding current (MIN)	114	10,232 A	8,000	12,000	PASS	MMA

## 11. USING MATCHCURVE

MatchCurve is a function that offers ready-made welding programs (curves) for FastMig Synergic, FastMig Pulse, KempArc and KempArc Pulse. MIG/MAG welding programs are made for different material, wire diameter, and shielding gas combinations.

You can buy welding programs in Kemppi DataStore and install them to the welding machine with Kemppi DataGun.

## 12. USING MATCHCUSTOM

MatchCustom is a function that offers custom-made welding programs for FastMig Synergic, FastMigPulse, KempArc and KempArcPulse. These welding programs do not exist in Kemppi DataStore, but they are customer-specific, and they are made to order.

To order MatchCustom software, please contact Kemppi's subsidiaries or Kemppi welding service. When you've placed the order, you can download your MatchCustom welding programs from Kemppi DataStore and install them to your welding machine the usual way with the Kemppi DataGun.

**KEMPPI OY**

Hennalankatu 39  
PL 13  
FIN-15801 LAHTI  
FINLAND  
Tel +358 3 899 11  
Telefax +358 3 899 428  
export@kemppi.com  
www.kemppi.com

**Kotimaan myynti:**

Tel +358 3 899 11  
Telefax +358 3 734 8398  
myynti.fi@kemppi.com

**KEMPPI SVERIGE AB**

Box 717  
S-194 27 UPPLANDS VÄSBY  
SVERIGE  
Tel +46 8 590 783 00  
Telefax +46 8 590 823 94  
sales.se@kemppi.com

**KEMPPI NORGE A/S**

Postboks 2151, Postterminalen  
N-3103 TØNSBERG  
NORGE  
Tel +47 33 346000  
Telefax +47 33 346010  
sales.no@kemppi.com

**KEMPPI DANMARK A/S**

Literbuen 11  
DK-2740 SKOVLUNDE  
DANMARK  
Tel +45 4494 1677  
Telefax +45 4494 1536  
sales.dk@kemppi.com

**KEMPPI BENELUX B.V.**

Postbus 5603  
NL-4801 EA BREDA  
NEDERLAND  
Tel +31 765717750  
Telefax +31 765716345  
sales.nl@kemppi.com

**KEMPPI (UK) Ltd**

Martti Kemppi Building  
Fraser Road  
Priory Business Park  
BEDFORD, MK44 3WH  
UNITED KINGDOM  
Tel +44 (0)845 6444201  
Telefax +44 (0)845 6444202  
sales.uk@kemppi.com

**KEMPPI FRANCE S.A.S.**

65 Avenue de la Couronne des Prés  
78681 EPONE CEDEX  
FRANCE  
Tel +33 1 30 90 04 40  
Telefax +33 1 30 90 04 45  
sales.fr@kemppi.com

**KEMPPI GmbH**

Otto-Hahn-Straße 14  
D-35510 BUTZBACH  
DEUTSCHLAND  
Tel +49 6033 88 020  
Telefax +49 6033 72 528  
sales.de@kemppi.com

**KEMPPI SPÓŁKA Z O.O.**

Ul. Borzymowska 32  
03-565 WARSZAWA  
POLAND  
Tel +48 22 7816162  
Telefax +48 22 7816505  
info.pl@kemppi.com

**KEMPPI AUSTRALIA PTY LTD.**

13 Cullen Place  
P.O. Box 5256, Greystanes NSW 2145  
SMITHFIELD NSW 2164  
AUSTRALIA  
Tel. +61 2 9605 9500  
Telefax +61 2 9605 5999  
info.au@kemppi.com

**OOO KEMPPИ**

Polkovaya str. 1, Building 6  
127018 MOSCOW  
RUSSIA  
Tel +7 495 739 4304  
Telefax +7 495 739 4305  
info.ru@kemppi.com

**ООО КЕМППИ**

ул. Полковная 1, строение 6  
127018 Москва  
Tel +7 495 739 4304  
Telefax +7 495 739 4305  
info.ru@kemppi.com

**KEMPPИ, TRADING (BEIJING) COMPANY, LIMITED**

Room 420, 3 Zone, Building B,  
No.12 Hongda North Street,  
Beijing Economic Development Zone,  
100176 Beijing  
CHINA  
Tel +86-10-6787 6064  
+86-10-6787 1282  
Telefax +86-10-6787 5259  
sales.cn@kemppi.com

肯倍贸易（北京）有限公司  
中国北京经济技术开发区宏达北路12号  
创新大厦B座三区420室（100176）  
电话：+86-10-6787 6064  
+86-10-6787 1282  
传真：+86-10-6787 5259  
sales.cn@kemppi.com

**KEMPPИ INDIA PVT LTD**

LAKSHMI TOWERS  
New No. 2/770,  
First Main Road,  
KAZURA Gardens,  
Neelangarai,  
CHENNAI - 600 041  
TAMIL NADU  
Tel +91-44-4567 1200  
Telefax +91-44-4567 1234  
sales.india@kemppi.com